

RoHS

This products can apply to the SWB Doc NO. QA-3-04-005 of Environmental&Material Management Rules

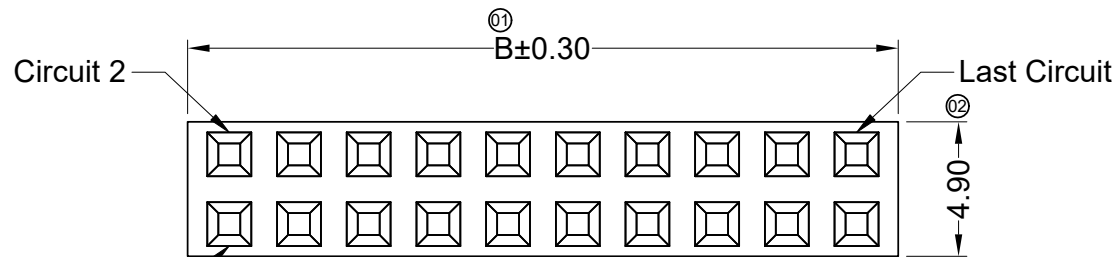

Specifications :

- Voltage rating: 250V AC / DC
- Current rating: 3A AC / DC
- Withstanding voltage: 800V AC/minute
- Temperature range: -40°C~+105°C
- Insulation resistance: ≥1000MΩ
- Contact resistance: ≤20mΩ
- After environmental testing: ≤30mΩ
- Material(Pin): Brass
- Mates With SWB Pin Header: 6501W

6501 F V X -2*XX A -XX V01 XX -01

① ② ③ ④ ⑤ ⑥ ⑦ ⑧ ⑨

- ① Series No.
- ② Category: F- Female Header Connector
- ③ Connector Type: V-180°
- ④ Mouting Type: Blank-DIP
- ⑤ Row No.-Pin No Per Row: 2*XX-Double row
- ⑥ Special NO.: A-H=8.55mm
- ⑦ Material: 9T-PA9T 94V-0;6T-PA6T 94V-0
- ⑧ Plating Code: V01-Gold Flash
- ⑨ Color: Blank-Black color

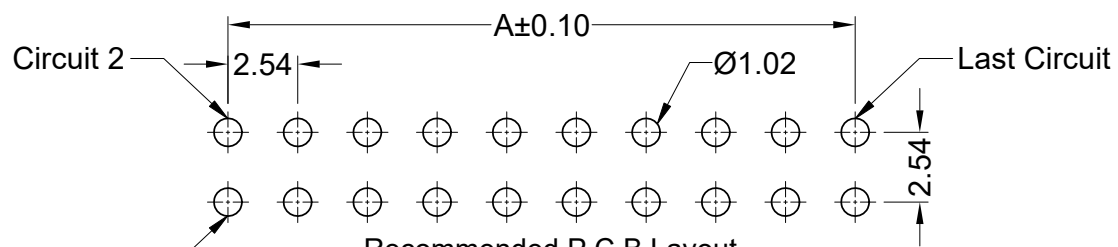
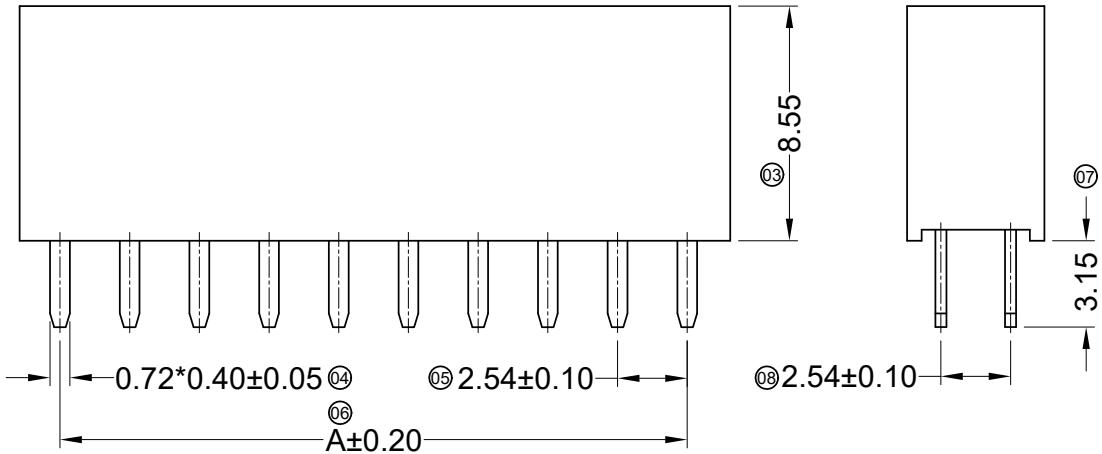

Recommended P.C.B Layout
General Tolerance±0.05

| Poles | Dimensions(mm) | | Poles | Dimensions(mm) | | Poles | Dimensions(mm) | |
|-------|----------------|-------|-------|----------------|-------|-------|----------------|-------|
| | A | B | | A | B | | A | B |
| 2*02 | 2.54 | 5.50 | 2*14 | 33.02 | 35.98 | 2*26 | 63.50 | 66.46 |
| 2*03 | 5.08 | 8.04 | 2*15 | 35.56 | 38.52 | 2*27 | 66.04 | 69.00 |
| 2*04 | 7.62 | 10.58 | 2*16 | 38.10 | 41.06 | 2*28 | 68.58 | 71.54 |
| 2*05 | 10.16 | 13.12 | 2*17 | 40.64 | 43.60 | 2*29 | 71.12 | 74.08 |
| 2*06 | 12.70 | 15.66 | 2*18 | 43.18 | 46.14 | 2*30 | 73.66 | 76.62 |
| 2*07 | 15.24 | 18.20 | 2*19 | 45.72 | 48.68 | 2*31 | 76.20 | 79.16 |
| 2*08 | 17.78 | 20.74 | 2*20 | 48.26 | 51.22 | 2*32 | 78.74 | 81.70 |
| 2*09 | 20.32 | 23.28 | 2*21 | 50.80 | 53.76 | 2*33 | 81.28 | 84.24 |
| 2*10 | 22.86 | 25.82 | 2*22 | 53.34 | 56.30 | 2*34 | 83.82 | 86.78 |
| 2*11 | 25.40 | 28.36 | 2*23 | 55.88 | 58.84 | 2*35 | 86.36 | 89.32 |
| 2*12 | 27.94 | 30.90 | 2*24 | 58.42 | 61.38 | 2*36 | 88.90 | 91.86 |
| 2*13 | 30.48 | 33.44 | 2*25 | 60.96 | 63.92 | 2*37 | 91.44 | 94.40 |

| | | | | | | | | | | | | | | |
|------------|-----|---------------|----------------------|--------|----------|--|--|--|--|---|-------|-------|-----|--------|
| | | | | | | 东莞市思索连接器有限公司 SWB CONNECTORS CO.,LTD | | | | PART NO. 6501FV-2*XXA-XXV01-01 | | | | |
| | | | | | | APPROVAL Smark Guo sylvia 2019/07/02 | | | | TITLE 2.54 mm Female Header Connectors | | | | |
| 2020/03/16 | B | EN20200316005 | Update Drawing Frame | Mandy | Robing | | | | | UNIT | SCALE | SHEET | REV | NUMBER |
| DATE | REV | ECN NO. | DESCRIPTION | MODIFY | APPROVAL | | | | | mm | 1:1 | 1/1 | B | A-213 |

RoHS

This products can apply to the SWB Doc NO. QA-3-04-005 of Environmental&Material Management Rules



Specifications :

- Voltage rating: 250V AC / DC
- Current rating: 3A AC / DC
- Withstanding voltage: 800V AC/minute
- Temperature range: -40°C~+105°C
- Insulation resistance: ≥1000MΩ
- Contact resistance: ≤20mΩ
- After environmental testing: ≤30mΩ
- Material(Pin): Brass
- Mates With SWB Pin Header: 6501W

6501 F V X -2*XX B -6T V01 XX

① ② ③ ④ ⑤ ⑥ ⑦ ⑧ ⑨

- ① Series No.
- ② Category: F- Female Header Connector
- ③ Connector Type: V-180°
- ④ Mouting Type: Blank-DIP
- ⑤ Row No.-Pin No Per Row : 2*XX-Double row
- ⑥ Special NO.: B-H=8.50mm DIP=2.64mm
- ⑦ Material: 6T-PA6T 94V-0
- ⑧ Plating Code: V01-Gold Flash
- ⑨ Color: Blank-Black color

| Poles | Dimensions(mm) | | Poles | Dimensions(mm) | | Poles | Dimensions(mm) | |
|-------|----------------|-------|-------|----------------|-------|-------|----------------|-------|
| | A | B | | A | B | | A | B |
| 2*02 | 2.54 | 5.50 | 2*14 | 33.02 | 35.98 | 2*26 | 63.50 | 66.46 |
| 2*03 | 5.08 | 8.04 | 2*15 | 35.56 | 38.52 | 2*27 | 66.04 | 69.00 |
| 2*04 | 7.62 | 10.58 | 2*16 | 38.10 | 41.06 | 2*28 | 68.58 | 71.54 |
| 2*05 | 10.16 | 13.12 | 2*17 | 40.64 | 43.60 | 2*29 | 71.12 | 74.08 |
| 2*06 | 12.70 | 15.66 | 2*18 | 43.18 | 46.14 | 2*30 | 73.66 | 76.62 |
| 2*07 | 15.24 | 18.20 | 2*19 | 45.72 | 48.68 | 2*31 | 76.20 | 79.16 |
| 2*08 | 17.78 | 20.74 | 2*20 | 48.26 | 51.22 | 2*32 | 78.74 | 81.70 |
| 2*09 | 20.32 | 23.28 | 2*21 | 50.80 | 53.76 | 2*33 | 81.28 | 84.24 |
| 2*10 | 22.86 | 25.82 | 2*22 | 53.34 | 56.30 | 2*34 | 83.82 | 86.78 |
| 2*11 | 25.40 | 28.36 | 2*23 | 55.88 | 58.84 | 2*35 | 86.36 | 89.32 |
| 2*12 | 27.94 | 30.90 | 2*24 | 58.42 | 61.38 | 2*36 | 88.90 | 91.86 |
| 2*13 | 30.48 | 33.44 | 2*25 | 60.96 | 63.92 | 2*37 | 91.44 | 94.40 |

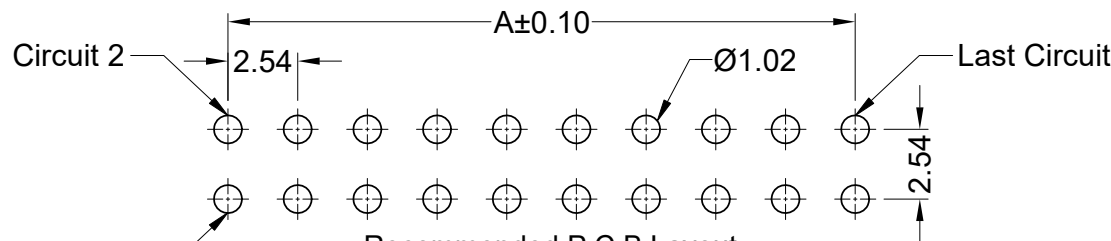
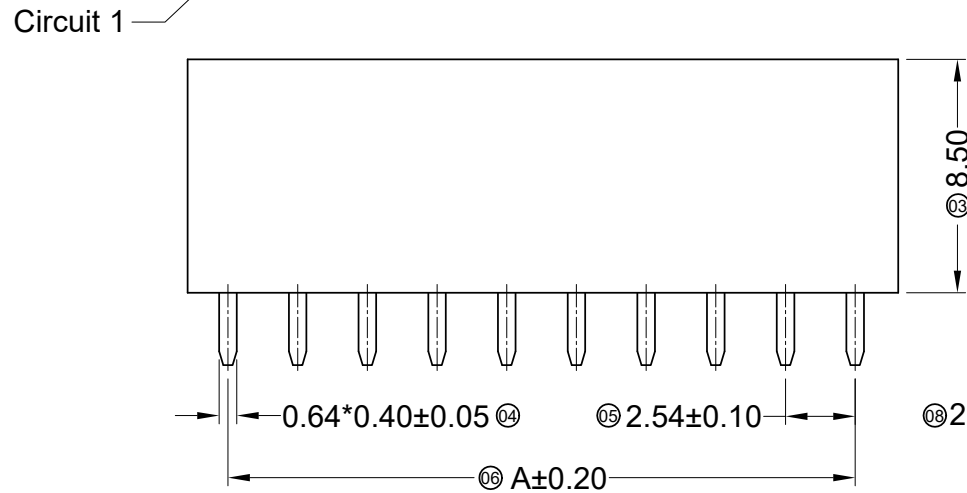
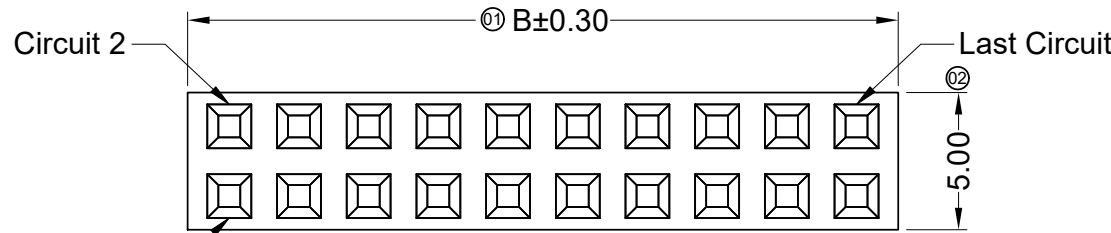

Recommended P.C.B Layout
General Tolerance±0.05

| | | | | | | | | | | | | | | | | | | | | | | |
|--|--|--|--|--|--|--|--|--|--|---|--|--|--|--|--|--|--|-------------------------------|--|--|--|--|
| | | | | | | <p>GENERAL TOLERANCE</p> <p>.X ±0.30</p> <p>.XX ±0.20</p> <p>.XXX ±0.10</p> <p>X.° ±2°</p> | | | | <p>东莞市思索连接器有限公司</p> <p>SWB CONNECTORS CO.,LTD</p> | | | | <p>PART NO. 6501FV-2*XXB-6TV01</p> | | | | | | | | |
| | | | | | | <p>APPROVAL</p> <p>Robing</p> | | | | <p>CHECK</p> <p>Jova</p> | | | | <p>DRAWN</p> <p>Wuxiaotao</p> | | | | <p>DATE</p> <p>2016/04/05</p> | | | | |
| | | | | | | <p>PROJECT</p> <p>Robing</p> | | | | <p>DATE</p> <p>2016/04/05</p> | | | | <p>TITLE</p> <p>2.54 mm Female Header Connectors</p> | | | | | | | | |
| | | | | | | <p>PROJECT</p> <p>Robing</p> | | | | <p>DATE</p> <p>2016/04/05</p> | | | | <p>UNIT</p> <p>mm</p> | | | | | | | | |
| | | | | | | <p>PROJECT</p> <p>Robing</p> | | | | <p>DATE</p> <p>2016/04/05</p> | | | | <p>SCALE</p> <p>1:1</p> | | | | | | | | |
| | | | | | | <p>PROJECT</p> <p>Robing</p> | | | | <p>DATE</p> <p>2016/04/05</p> | | | | <p>SHEET</p> <p>1/1</p> | | | | | | | | |
| | | | | | | <p>PROJECT</p> <p>Robing</p> | | | | <p>DATE</p> <p>2016/04/05</p> | | | | <p>REV</p> <p>B</p> | | | | | | | | |
| | | | | | | <p>PROJECT</p> <p>Robing</p> | | | | <p>DATE</p> <p>2016/04/05</p> | | | | <p>NUMBER</p> <p>A-213</p> | | | | | | | | |

| | | | | | |
|------------|-----|---------------|----------------------|--------|----------|
| 2020/03/16 | B | EN20200316005 | Update Drawing Frame | Mandy | Robing |
| DATE | REV | ECN NO. | DESCRIPTION | MODIFY | APPROVAL |

RoHS

This products can apply to the SWB Doc NO. QA-3-04-005 of Environmental&Material Management Rules



■ Specifications :

- Voltage rating: 250V AC / DC
- Current rating: 3A AC / DC
- Withstanding voltage: 800V AC/minute
- Temperature range: -40°C~+105°C
- Insulation resistance: ≥1000MΩ
- Contact resistance: ≤20mΩ
- After environmental testing: ≤30mΩ
- Material (Pin): Phosphor bronze
- Mates With SWB Pin Header: 6501WX

6501 F V S-2*XX P-XX V01 XX C -03

- ① Series No.
- ② Category: F-Female Header Connector
- ③ Connector Type: V- Straight 180°
- ④ Mounting Type: S-SMT
- ⑤ Row No.-Pin No.: 2*XX-2*02P-2*40P
- ⑥ Plug the Pin & Special No.: P-With Peg
- ⑦ Material: 6T-PA6T 94V-0 ;9T-PA9T 94V-0
- ⑧ Plating Code: V01-Gold Flash
- ⑨ Color: Blank-Black Color
- ⑩ Packing: C- Reel With Cap
- ⑪ 03-3.55/7.20

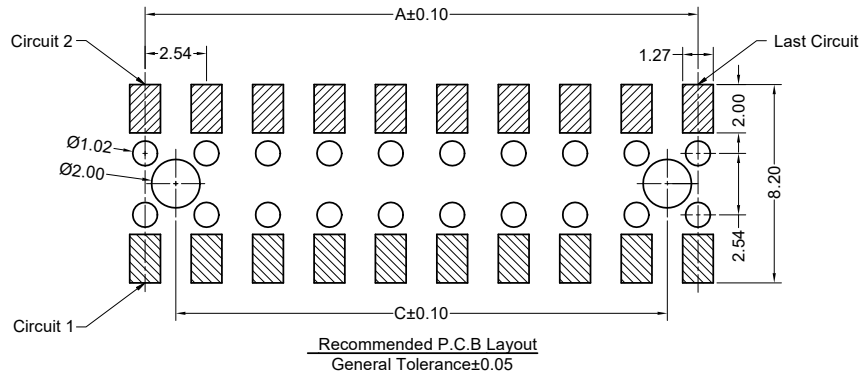
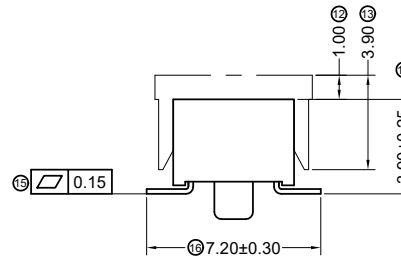
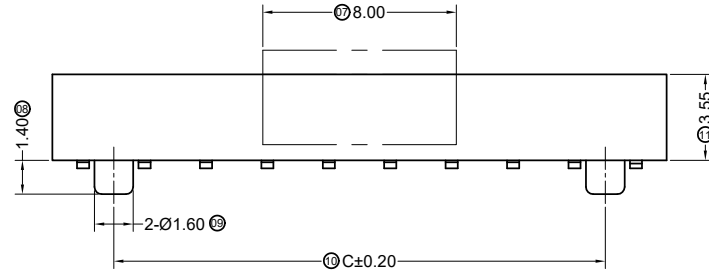
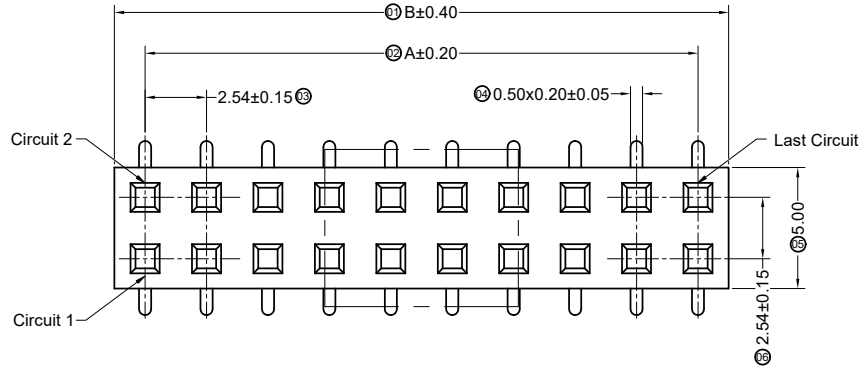

| Poles | Dimensions (mm) | | | Poles | Dimensions (mm) | | | Poles | Dimensions (mm) | | |
|-------|-----------------|-------|-------|-------|-----------------|-------|-------|-------|-----------------|--------|-------|
| | A | B | C | | A | B | C | | A | B | C |
| 2*02 | 2.54 | 5.08 | | 2*15 | 35.56 | 38.10 | 33.02 | 2*28 | 68.58 | 71.12 | 66.04 |
| 2*03 | 5.08 | 7.62 | 2.54 | 2*16 | 38.10 | 40.64 | 35.56 | 2*29 | 71.12 | 73.66 | 68.58 |
| 2*04 | 7.62 | 10.16 | 5.08 | 2*17 | 40.64 | 43.18 | 38.10 | 2*30 | 73.66 | 76.20 | 71.12 |
| 2*05 | 10.16 | 12.70 | 7.62 | 2*18 | 43.18 | 45.72 | 40.64 | 2*31 | 76.20 | 78.74 | 73.66 |
| 2*06 | 12.70 | 15.24 | 10.16 | 2*19 | 45.72 | 48.26 | 43.18 | 2*32 | 78.74 | 81.28 | 76.20 |
| 2*07 | 15.24 | 17.78 | 12.70 | 2*20 | 48.26 | 50.80 | 45.72 | 2*33 | 81.28 | 83.82 | 78.74 |
| 2*08 | 17.78 | 20.32 | 15.24 | 2*21 | 50.80 | 53.34 | 48.26 | 2*34 | 83.82 | 86.36 | 81.28 |
| 2*09 | 20.32 | 22.86 | 17.78 | 2*22 | 53.34 | 55.88 | 50.80 | 2*35 | 86.36 | 88.90 | 83.82 |
| 2*10 | 22.86 | 25.40 | 20.32 | 2*23 | 55.88 | 58.42 | 53.34 | 2*36 | 88.90 | 91.44 | 86.36 |
| 2*11 | 25.40 | 27.94 | 22.86 | 2*24 | 58.42 | 60.96 | 55.88 | 2*37 | 91.44 | 93.98 | 88.90 |
| 2*12 | 27.94 | 30.48 | 25.40 | 2*25 | 60.96 | 63.50 | 58.42 | 2*38 | 93.98 | 96.52 | 91.44 |
| 2*13 | 30.48 | 33.02 | 27.94 | 2*26 | 63.50 | 66.04 | 60.96 | 2*39 | 96.52 | 99.06 | 93.98 |
| 2*14 | 33.02 | 35.56 | 30.48 | 2*27 | 66.04 | 68.58 | 63.50 | 2*40 | 99.06 | 101.60 | 96.52 |

| | | | | | | | | | | | | | | | | | |
|------|-----|---------|-------------|--------|---|---------|--------|----------|---|------------|------|-------|-------------------------------------|-----|--------|--|--|
| | | | | | GENERAL TOLERANCE .X ±0.30 .XX ±0.20 .XXX ±0.10 / | | | | 东莞市思索连接器有限公司 SWB CONNECTORS CO.,LTD | | | | PART NO. 6501FVS-2*XXP-XXV01C-03 | | | | |
| | | | | | APPROVAL CHECK DRAWN DATE | | | | TITLE 2.54 mm Female Header Connectors | | | | | | | | |
| DATE | REV | ECN NO. | DESCRIPTION | MODIFY | APPROVAL | PROJECT | Robing | Alan Qin | Mandy | 2020/03/16 | UNIT | SCALE | SHEET | REV | NUMBER | | |
| | | | | | | | | | | | mm | 1:1 | 1/1 | A | A-268 | | |

RoHS

This products can apply to the SWB Doc NO. QA-3-04-005 of Environmental&Material Management Rules

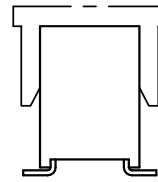
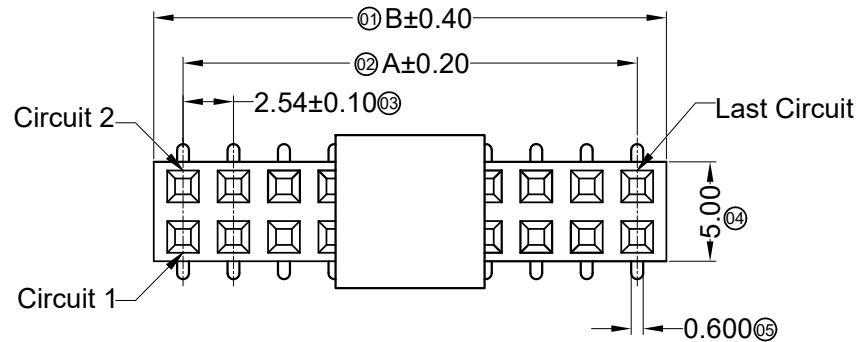

Without Post

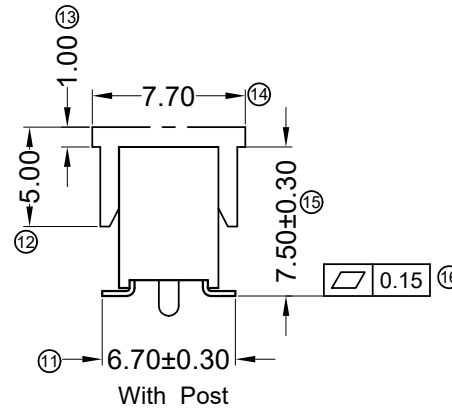

With Post

Specifications :

- Voltage rating: 250V AC / DC
- Current rating: 3A AC / DC
- Withstanding voltage: 800V AC/minute
- Temperature range: -40°C~+105°C
- Insulation resistance: ≥1000MΩ
- Contact resistance: ≤20mΩ
- After environmental testing: ≤30mΩ
- Material(Pin):Phosphor bronze
- Mates With SWB Pin Header:6501WX

6501 F V S-2*XX X-6T V01 XX

① ②③④ ⑤ ⑥ ⑦ ⑧ ⑨

- ① Series No.
- ② Category: F-Female Header Connector
- ③ Connector Type: V- Straight 180°
- ④ Mouting Type: S-SMT
- ⑤ Row No.-Pin No Per Row: 2*XX-2*02P~2*40P
- ⑥ Plug the Pin & Special No.: S-With Post
Blank-Without Post
- ⑦ Material: 6T-PA6T 94V-0
- ⑧ Plating Code: V01- Gold Flash
- ⑨ Color: Blank-Black color

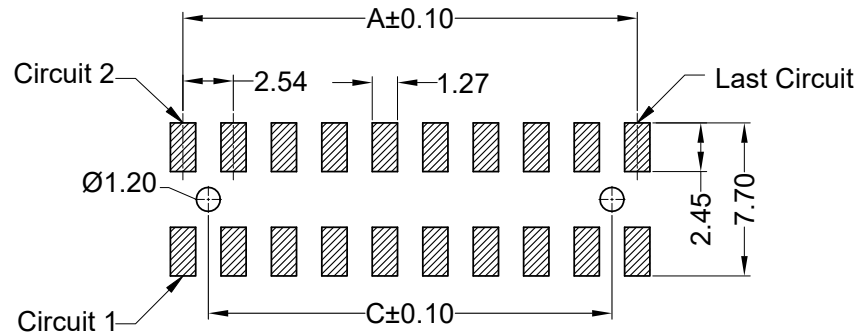
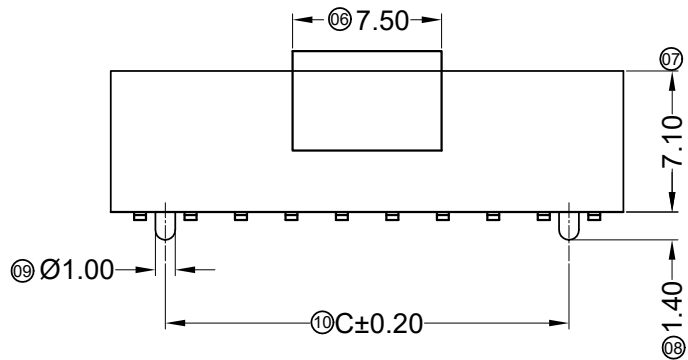

Recommended P.C.B Layout
General Tolerance±0.05



| Poles | Dimensions (mm) | | | Poles | Dimensions (mm) | | | Poles | Dimensions (mm) | | |
|-------|-----------------|-------|-------|-------|-----------------|-------|-------|-------|-----------------|--------|-------|
| | A | B | C | | A | B | C | | A | B | C |
| 2*02 | 2.54 | 5.48 | | 2*15 | 35.56 | 38.50 | 33.02 | 2*28 | 68.58 | 71.52 | 66.04 |
| 2*03 | 5.08 | 8.02 | 2.54 | 2*16 | 38.10 | 41.04 | 35.56 | 2*29 | 71.12 | 74.06 | 68.58 |
| 2*04 | 7.62 | 10.56 | 5.08 | 2*17 | 40.64 | 43.58 | 38.10 | 2*30 | 73.66 | 76.60 | 71.12 |
| 2*05 | 10.16 | 13.10 | 7.62 | 2*18 | 43.18 | 46.12 | 40.64 | 2*31 | 76.20 | 79.14 | 73.66 |
| 2*06 | 12.70 | 15.64 | 10.16 | 2*19 | 45.72 | 48.66 | 43.18 | 2*32 | 78.74 | 81.68 | 76.20 |
| 2*07 | 15.24 | 18.18 | 12.70 | 2*20 | 48.26 | 51.20 | 45.72 | 2*33 | 81.28 | 84.22 | 78.74 |
| 2*08 | 17.78 | 20.72 | 15.24 | 2*21 | 50.80 | 53.74 | 48.26 | 2*34 | 83.82 | 86.76 | 81.28 |
| 2*09 | 20.32 | 23.26 | 17.78 | 2*22 | 53.34 | 56.28 | 50.80 | 2*35 | 86.36 | 89.30 | 83.82 |
| 2*10 | 22.86 | 25.80 | 20.32 | 2*23 | 55.88 | 58.82 | 53.34 | 2*36 | 88.90 | 91.84 | 86.36 |
| 2*11 | 25.40 | 28.34 | 22.86 | 2*24 | 58.42 | 61.36 | 55.88 | 2*37 | 91.44 | 94.38 | 88.90 |
| 2*12 | 27.94 | 30.88 | 25.40 | 2*25 | 60.96 | 63.90 | 58.42 | 2*38 | 93.98 | 96.92 | 91.44 |
| 2*13 | 30.48 | 33.42 | 27.94 | 2*26 | 63.50 | 66.44 | 60.96 | 2*39 | 96.52 | 99.46 | 93.98 |
| 2*14 | 33.02 | 35.96 | 30.48 | 2*27 | 66.04 | 68.98 | 63.50 | 2*40 | 99.06 | 102.00 | 96.52 |

| | | | | | | | | | | | | | | | | | | | | | | | | | | | | | | | | | | |
|------------|-----|---------------|---------------------------------|--------|----------|---|--|--|--|---|--|--|--|--|--|----------------------------------|-------|-------|-----|-------------------------------|--|--|--|--|---------------------|--|--|--|--|----------------------------|--|--|--|--|
| | | | | | | <p>GENERAL TOLERANCE</p> <p>.X ±0.30</p> <p>.XX ±0.20</p> <p>.XXX ±0.10</p> | | | | <p>东莞市思索连接器有限公司</p> <p>SWB CONNECTORS CO.,LTD</p> | | | | | <p>PART NO.</p> <p>6501FVS-2*XXX-6TV01</p> | | | | | | | | | | | | | | | | | | | |
| | | | | | | <p>APPROVAL</p> <p>Robing</p> | | | | <p>CHECK</p> <p>Alan qin</p> | | | | | <p>DRAWN</p> <p>Yu wei</p> | | | | | <p>DATE</p> <p>2017/09/18</p> | | | | | | | | | | | | | | |
| | | | | | | <p>PROJECT</p> <p>Robing</p> | | | | <p>UNIT</p> <p>mm</p> | | | | | <p>SCALE</p> <p>1:1</p> | | | | | <p>SHEET</p> <p>1/1</p> | | | | | <p>REV</p> <p>B</p> | | | | | <p>NUMBER</p> <p>A-013</p> | | | | |
| 2020/03/09 | B | ER20200309001 | Change the cover of the product | Mandy | Robing | | | | | | | | | | | 2.54 mm Female Header Connectors | | | | | | | | | | | | | | | | | | |
| DATE | REV | ECN NO. | DESCRIPTION | MODIFY | APPROVAL | | | | | | | | | | | UNIT | SCALE | SHEET | REV | NUMBER | | | | | | | | | | | | | | |

RoHS

This products can apply to the SWB Doc NO. QA-3-04-005 of Environmental&Material Management Rules

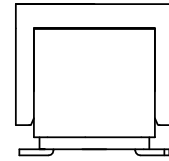
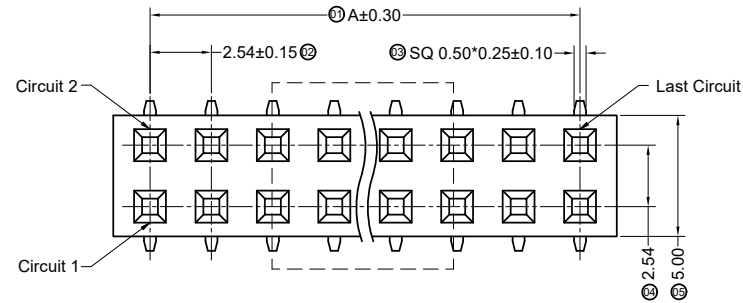

Without Post

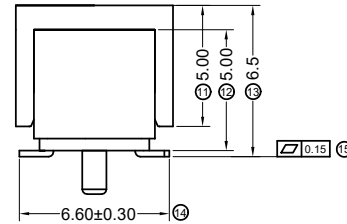
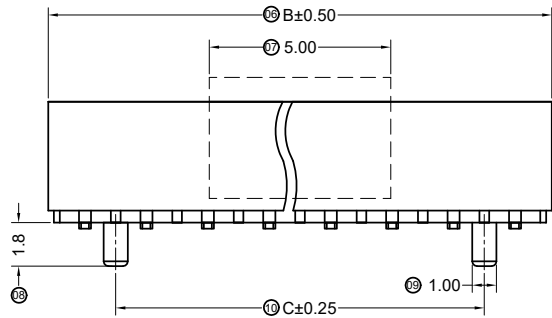

With Post

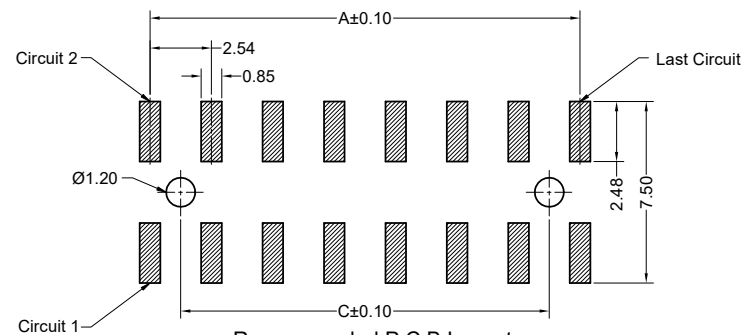

Recommended P.C.B Layout
General Tolerance±0.05



■ Specifications :

- Voltage rating: 250V AC / DC
- Current rating: 3A AC / DC
- Withstanding voltage: 1000V AC/minute
- Temperature range: -40°C~+105°C
- Insulation resistance: ≥1000MΩ
- Contact resistance: ≤20mΩ
- After environmental testing: ≤30mΩ
- Material(Pin):Phosphor bronze
- Mates With SWB Pin Header:6501WX

6501 F V S-2*XX X-6T V01 XX-01

① ② ③ ④ ⑤ ⑥ ⑦ ⑧ ⑨

- ① Series No.
- ② Category: F-Female Header Connector
- ③ Connector Type: V- Straight 180°
- ④ Mounting Type: S-SMT
- ⑤ Row No.-Pin No Per Row: 2*XX-2*02P~2*40P
- ⑥ Plug the Pin & Special No.: S-With Post
Blank-Without Post
- ⑦ Material: 6T-PA6T 94V-0
- ⑧ Plating Code: V01-Gold Flash
- ⑨ Color: Blank-Black Color
01-5.00/6.60

| Poles | Dimensions (mm) | | | Poles | Dimensions (mm) | | | Poles | Dimensions (mm) | | |
|-------|-----------------|-------|-------|-------|-----------------|-------|-------|-------|-----------------|--------|-------|
| | A | B | C | | A | B | C | | A | B | C |
| 2*02 | 2.54 | 5.58 | | 2*15 | 35.56 | 38.60 | 33.02 | 2*28 | 68.58 | 71.62 | 66.04 |
| 2*03 | 5.08 | 8.12 | 2.54 | 2*16 | 38.10 | 41.14 | 35.56 | 2*29 | 71.12 | 74.16 | 68.58 |
| 2*04 | 7.62 | 10.66 | 5.08 | 2*17 | 40.64 | 43.68 | 38.10 | 2*30 | 73.66 | 76.70 | 71.12 |
| 2*05 | 10.16 | 13.20 | 7.62 | 2*18 | 43.18 | 46.22 | 40.64 | 2*31 | 76.20 | 79.24 | 73.66 |
| 2*06 | 12.70 | 15.74 | 10.16 | 2*19 | 45.72 | 48.76 | 43.18 | 2*32 | 78.74 | 81.78 | 76.20 |
| 2*07 | 15.24 | 18.28 | 12.70 | 2*20 | 48.26 | 51.30 | 45.72 | 2*33 | 81.28 | 84.32 | 78.74 |
| 2*08 | 17.78 | 20.82 | 15.24 | 2*21 | 50.80 | 53.84 | 48.26 | 2*34 | 83.82 | 86.86 | 81.28 |
| 2*09 | 20.32 | 23.36 | 17.78 | 2*22 | 53.34 | 56.38 | 50.80 | 2*35 | 86.36 | 89.40 | 83.82 |
| 2*10 | 22.86 | 25.90 | 20.32 | 2*23 | 55.88 | 58.92 | 53.34 | 2*36 | 88.90 | 91.94 | 86.36 |
| 2*11 | 25.40 | 28.44 | 22.86 | 2*24 | 58.42 | 61.46 | 55.88 | 2*37 | 91.44 | 94.48 | 88.90 |
| 2*12 | 27.94 | 30.98 | 25.40 | 2*25 | 60.96 | 64.00 | 58.42 | 2*38 | 93.98 | 97.02 | 91.44 |
| 2*13 | 30.48 | 33.52 | 27.94 | 2*26 | 63.50 | 66.54 | 60.96 | 2*39 | 96.52 | 99.56 | 93.98 |
| 2*14 | 33.02 | 36.06 | 30.48 | 2*27 | 66.04 | 69.08 | 63.50 | 2*40 | 99.06 | 102.10 | 96.52 |

| | |
|-------------------|-------|
| GENERAL TOLERANCE | |
| .X | ±0.30 |
| .XX | ±0.20 |
| .XXX | ±0.10 |
| / | |



东莞市思索连接器有限公司

SWB CONNECTORS CO.,LTD

| | | | |
|----------|-------|-------|------------|
| APPROVAL | CHECK | DRAWN | DATE |
| Robing | Alan | Mandy | 2019/09/18 |

PART NO.
6501FVS-2*XXX-6TV01-01

TITLE
2.54 mm Female Header Connectors

| | | | | |
|------|-------|-------|-----|--------|
| UNIT | SCALE | SHEET | REV | NUMBER |
| mm | 1:1 | 1/1 | A | A-195 |

| | | | | | |
|------|-----|---------|-------------|--------|----------|
| DATE | REV | ECN NO. | DESCRIPTION | MODIFY | APPROVAL |
| | | | | | |

RoHS

This products can apply to the SWB Doc NO. QA-3-04-005 of Environmental&Material Management Rules

Specifications :

- Voltage rating: 250V AC / DC
- Current rating: 3A AC / DC
- Withstanding voltage: 1000V AC/minute
- Temperature range: -40°C~+105°C
- Insulation resistance: ≥1000MΩ
- Contact resistance: ≤20mΩ
- After environmental testing: ≤30mΩ
- Material(Pin): phosphor Bronze
- Mates With SWB Wafer: 6501WX

6501 F V S - XX D - 6T V01 XX

① ② ③ ④ ⑤ ⑥ ⑦ ⑧ ⑨

- ① Series No.
- ② Category: F-Female Header Connector
- ③ Connector Type: V- Straight 180°
- ④ Mouting type: S-SMT
- ⑤ Row No.-Pin No Per Row: XX-Single row
- ⑥ Special No.: D-3.55/4.60
- ⑦ Material: 6T-PA6T 94V-0
- ⑧ Plating Category: V01-Gold Flash ; Ni: 50u" Over
- ⑨ Color: BK-Black Color

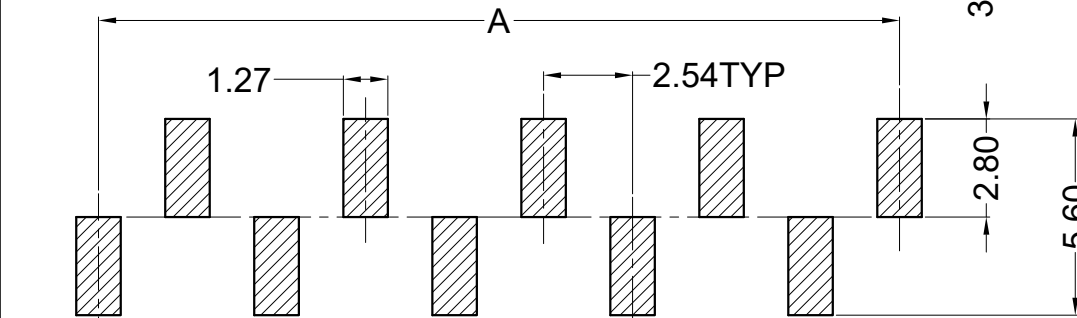
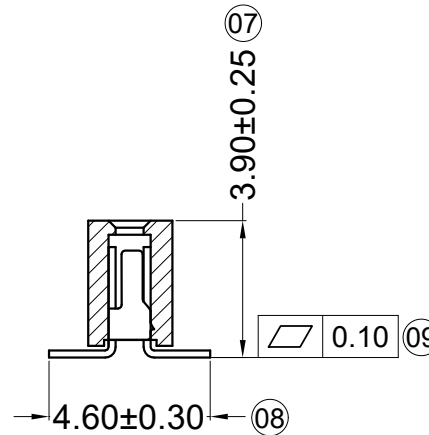
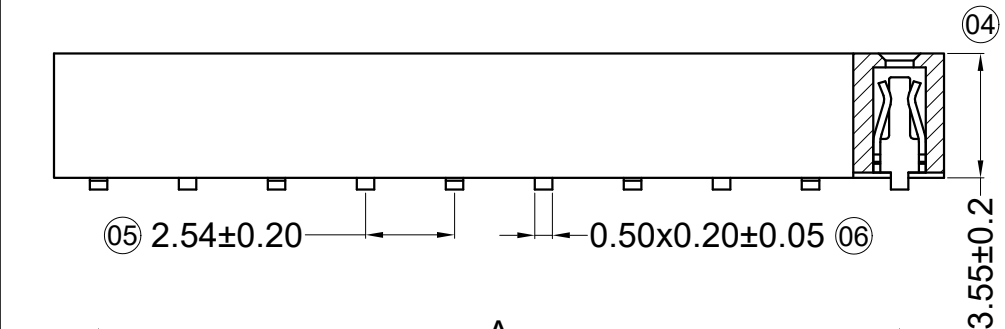
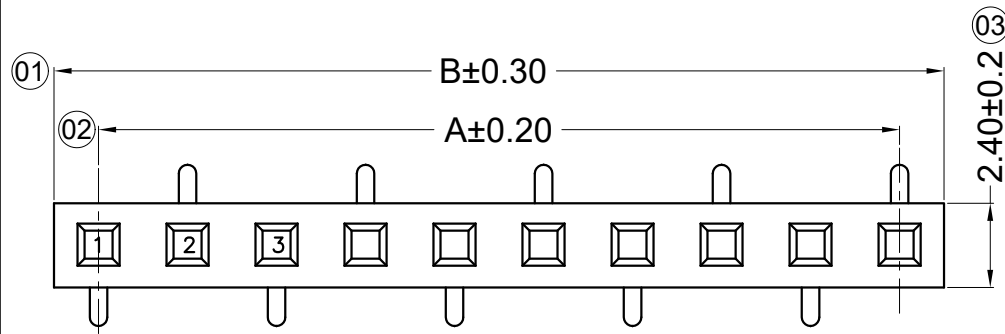

Recommended P.C.B Layout
General Tolerance±0.05



| Poles | Dimensions (mm) | | Poles | Dimensions (mm) | | Poles | Dimensions (mm) | |
|-------|-----------------|-------|-------|-----------------|-------|-------|-----------------|--------|
| | A | B | | A | B | | A | B |
| 01 | -- | 2.54 | 15 | 35.56 | 38.10 | 29 | 71.12 | 73.66 |
| 02 | 2.54 | 5.08 | 16 | 38.10 | 40.64 | 30 | 73.66 | 76.20 |
| 03 | 5.08 | 7.62 | 17 | 40.64 | 43.18 | 31 | 76.20 | 78.74 |
| 04 | 7.62 | 10.16 | 18 | 43.18 | 45.72 | 32 | 78.74 | 81.28 |
| 05 | 10.16 | 12.70 | 19 | 45.72 | 48.26 | 33 | 81.28 | 83.82 |
| 06 | 12.70 | 15.24 | 20 | 48.26 | 50.80 | 34 | 83.82 | 86.36 |
| 07 | 15.24 | 17.78 | 21 | 50.80 | 53.34 | 35 | 86.36 | 88.90 |
| 08 | 17.78 | 20.32 | 22 | 53.34 | 55.88 | 36 | 88.90 | 91.44 |
| 09 | 20.32 | 22.86 | 23 | 55.88 | 58.42 | 37 | 91.44 | 93.98 |
| 10 | 22.86 | 25.40 | 24 | 58.42 | 60.96 | 38 | 93.98 | 96.52 |
| 11 | 25.40 | 27.94 | 25 | 60.96 | 63.50 | 39 | 96.52 | 99.06 |
| 12 | 27.94 | 30.48 | 26 | 63.50 | 66.04 | 40 | 99.06 | 101.60 |
| 13 | 30.48 | 33.02 | 27 | 66.04 | 68.58 | | | |
| 14 | 33.02 | 35.56 | 28 | 68.58 | 71.12 | | | |

| DATE | REV | ECN NO. | DESCRIPTION | MODIFY | APPROVAL |
|------|-----|---------|-------------|--------|----------|
| 1 | | | | | |
| 2 | | | | | |
| 3 | | | | | |
| 4 | | | | | |

| |
|-------------------|
| GENERAL TOLERANCE |
| .X ±0.35 |
| .XX ±0.25 |
| .XXX ±0.15 |
| X.° ±2° |
| PROJECT |
| |

东莞市思索连接器有限公司
SWB CONNECTORS CO.,LTD
 APPROVAL: Robing CHECK: Joshua DRAWN: Savvy DATE: 2017/07/10

| | | | | |
|-------------------------------------|-------|-------|-----|--------|
| PART NO. | | | | |
| 6501FVS-XXD-6TV01 | | | | |
| TITLE | | | | |
| 2.54mm SMT Female Header Connectors | | | | |
| UNIT | SCALE | SHEET | REV | NUMBER |
| mm | 1:1 | 1/1 | A | A-213 |

RoHS

This products can apply to the SWB Doc NO. QA-3-04-005 of Environmental&Material Management Rules

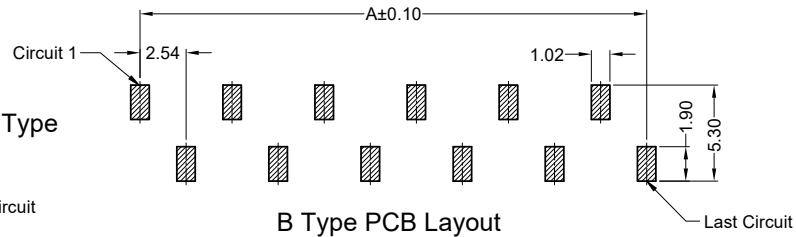
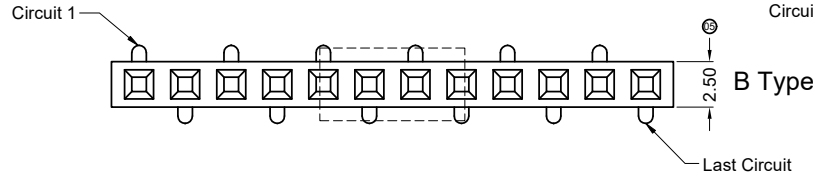
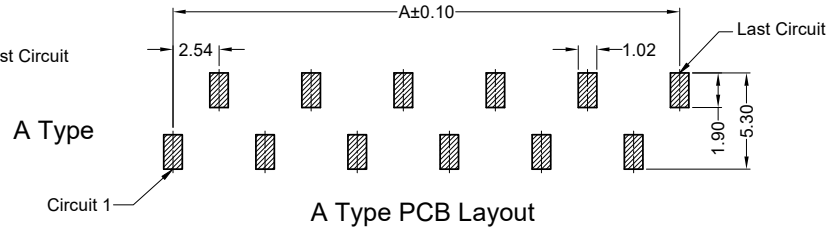
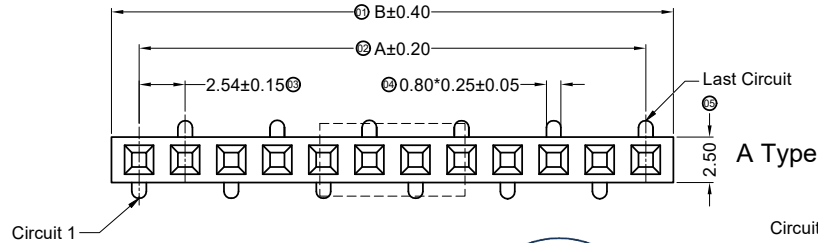

■ Specifications :

- Voltage rating: 250V AC / DC
- Current rating: 3A AC / DC
- Withstanding voltage: 1000V AC/minute
- Temperature range: -40°C~+105°C
- Insulation resistance: ≥1000MΩ
- Contact resistance: ≤20mΩ
- After environmental testing: ≤30mΩ
- Material(Pin):Phosphor Bronze
- Mates With SWB Or Pin Header:6501WX

6501 F V S-XX XX-6T V01 XX C

① ②③④⑤⑥⑦⑧⑨⑩

- ① Series No.
- ② Category: F-Female Header Connector
- ③ Connector Type: V- Straight 180°
- ④ Mounting Type: S-SMT
- ⑤ Row No.-Pin No Per Row: XX-Single Row
- ⑥ Plug the Pin & Special No. :A-A type; B-B type
- ⑦ Material: 6T-PA6T 94V-0
- ⑧ Plating Code: V01-Gold Flash
- ⑨ Color: Blank-Black color
- ⑩ Packing : C-Reel with Cap

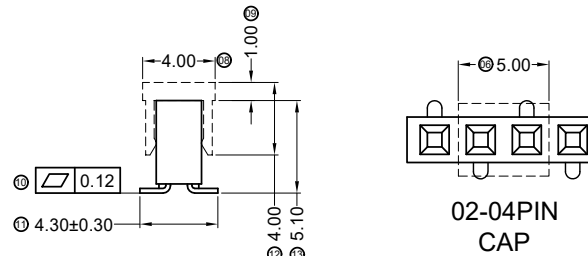
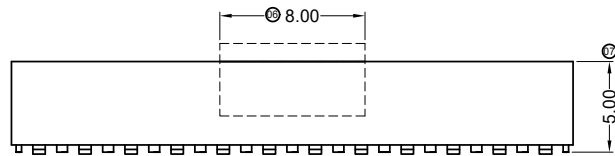

| Poles | Dimensions (mm) | | Poles | Dimensions (mm) | |
|-------|-----------------|-------|-------|-----------------|-------|
| | A | B | | A | B |
| 02 | 2.54 | 5.48 | 16 | 38.10 | 41.04 |
| 03 | 5.08 | 8.02 | 17 | 40.64 | 43.58 |
| 04 | 7.62 | 10.56 | 18 | 43.18 | 46.12 |
| 05 | 10.16 | 13.10 | 19 | 45.72 | 48.66 |
| 06 | 12.70 | 15.64 | 20 | 48.26 | 51.20 |
| 07 | 15.24 | 18.18 | 21 | 50.80 | 53.74 |
| 08 | 17.78 | 20.72 | 22 | 53.34 | 56.28 |
| 09 | 20.32 | 23.26 | 23 | 55.88 | 58.82 |
| 10 | 22.86 | 25.80 | 24 | 58.42 | 61.36 |
| 11 | 25.40 | 28.34 | 25 | 60.96 | 63.90 |
| 12 | 27.94 | 30.88 | 26 | 63.50 | 66.44 |
| 13 | 30.48 | 33.42 | 27 | 66.04 | 68.98 |
| 14 | 33.02 | 35.96 | 28 | 68.58 | 71.52 |
| 15 | 35.56 | 38.50 | 29 | 71.12 | 74.06 |

| DATE | REV | ECN NO. | DESCRIPTION | MODIFY | APPROVAL | PROJECT | APPROVAL | CHECK | DRAWN | DATE | UNIT | SCALE | SHEET | REV | NUMBER | |
|------------|-----|---------------|---|--------|----------|-------------------|--|----------|--------|------------|------|-------|-------|-----|--------|-------|
| 2020/03/16 | F | EN20170513002 | Update Drawing Frame, The Same ECR And ECN No | Mandy | Robing | GENERAL TOLERANCE | 东莞市思索连接器有限公司 SWB CONNECTORS CO.,LTD | APPROVAL | CHECK | DRAWN | DATE | mm | 1 : 1 | 1/1 | F | A-213 |
| 2017/05/13 | E | EN20170513002 | Increase CAP | Wei yu | Jacky | .X ±0.30 | | | | | | | | | | |
| | | | | | | .XX ±0.20 | | | | | | | | | | |
| | | | | | | .XXX ±0.10 | | | | | | | | | | |
| | | | | | | X.° ±2° | | | | | | | | | | |
| | | | | | | PROJECT | | | | | | | | | | |
| | | | | | | | Robing | Joshua | sylvia | 2014/10/29 | | | | | | |

PART NO. 6501FVS-XXA-6TV01C
6501FVS-XXB-6TV01C

TITLE
2.54 mm Female Header Connectors